



**Dual INTERNAL (SATA)/EXTERNAL (USB)
2.5" SATA HDD Enclosure
RX251-US**
User's Manual



RX251-US Product Specification

Model	RX251-US
Chipset	JM20336
Internal Interface	2.5" SATA hard drive
External Interface	-Portable Mode : USB2.0 -Mobile Rack Mode : SATA I
Hard Drive Capacity Supported	Up to 160GB
Hard Drive size supported	9.5mm (height)
Power Supply	-Portable Mode : USB bus power - Mobile Rack Mode : 4 pin to board
Operating System Supported	-Windows 2000/ME/XP/VISTA -Linux kernel 2.4.1 after -Mac OS 9.x/10.x and above
Transfer rate	-USB2.0 : Up to 480Mbps -SATA : Up to 1.5 Gps
Size(L x W x H)	- External enclosure : 141x73x16mm - Insertion bay 3.5" : 144x100x24mm

RX251-US Introduction

1. The RX251-US is divided into three parts:

A. 3.5" Insertion Bay



B. 5.25 Bracket



C. 2.5" SATA HDD Enclosure.



2. Accessories







No.	Description
1	Screws for fixing the 5.25" bracket to the PC case.
2	Screws for fixing the 3.5" insertion bay to 5.25" bracket or to a 3.5" drive bay.
3	Screws for fixing a 2.5" SATA hard drive in the 2.5" enclosure.
4	4-Pin power cable to connect to the power supply.
5	SATA cable to connect the 3.5" bay and motherboard.
6	USB 2.0 cable to connect 2.5" enclosure to the computer.
7	USB-Y cable to connect 2.5" enclosure to the computer for providing extra power.

RX251-US Hardware Installation

The RX251-US can be used as mobile rack function in desktop PC and an external storage. The detailed installation steps are as below:

A. Install the hard drive in the enclosure

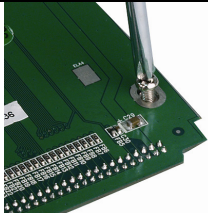

	Unscrew the external enclosure by screw driver.
	Open the panel of the enclosure and slide the board out.

	<p>Connect the 2.5" SATA hard drive to the connector on the board. Please check the HDD & board's pin is match when installation. Turn over the board and fix the board and hard drive by screws.</p>
	<p>Slide the board with the hard drive back into the enclosure.</p>
	<p>Close the panel and fix it by screws.</p>

B. In Desktop PC



There are two ways to use the RX251-US in the desktop PC.

Method 1: Install the RX251-US in the 5.25" drive bay

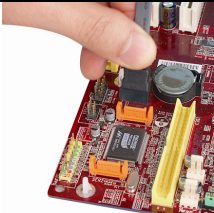
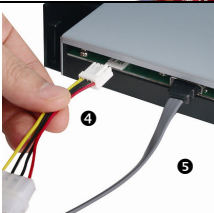
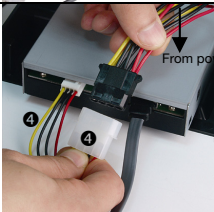

	<p>Slide the 3.5" insertion bay into the 5.25" bracket.</p>
	<p>Fasten the 3.5" insertion bay on the 5.25" bracket by screws.</p>

		<p>Slide the 3.5" insertion bay and 5.25" bracket into the available 5.25" drive bay in the PC case.</p>
		<p>Fasten the 5.25" bracket in the PC case by screws ①.</p>
		<p>Connect the one side of the SATA cable ⑤ to the back of the 3.5" insertion bay.</p>

		<p>Connect the other side of the SATA cable to SATA port on the motherboard. If your motherboard doesn't have on-board SATA port, you may install the SATA add-on cards and connect the SATA cable to it.</p>
		<p>Connect the 4-pin power cable 4 to the back of the 3.5" insertion bay.</p>
		<p>Connect the 4-pin power cable 4 to the power supply. Please refer to the manual of the power supply.</p>

		<p>Slide the 2.5" enclosure to the 3.5" insertion bay to the end till the ejection button is up. Now you can freely access the hard drive.</p>
		<p>When you want to take the enclosure out, please press the ejection button, the enclosure will be out.</p>

Method 2: Install the RX251-US in the 3.5" drive bay

		<p>Slide the 3.5" insertion bay into the available 3.5" drive bay.</p>
		<p>Fasten the 3.5" insertion bay in the PC case by screws 2.</p>

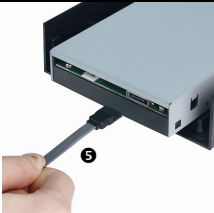
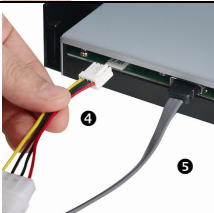
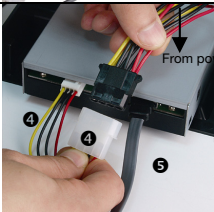
		<p>Connect the one side of the SATA cable 5 to the back of the 3.5" insertion bay</p>
		<p>Connect the 4-pin power cable 4 to the back of the 3.5" insertion bay.</p>
		<p>Connect the 4-pin power cable 4 to the power supply. Please refer to the manual of the power supply.</p>

		<p>Slide the 2.5" enclosure to the 3.5" insertion bay to the end till the ejection button is up. Now you can freely access the hard drive.</p>
		<p>When you want to take the enclosure out, please press the ejection button, the enclosure will be out.</p>

C. Portable external storage

		<p>Take out the enclosure from the PC.</p>
		<p>Plug the USB cable to the enclosure.</p>
		<p>Connect the USB cable ⑥ to the available port on the computer.</p>

		<p>If the hard drive needs more power, please connect the USB-Y cable 7 to increase the power efficiency.</p>
		<p>Connect the USB-Y 7 cable to the available USB port on the computer.</p>

Thank you for purchasing a quality Rosewill Product.

Please register your product at: www.rosewill.com for complete warranty information and future support for your product.